

Varenummer: 20081210
Beskrivelse: E+G Indstilleligt spændegreb
GN 302-45-B6-SW, sort

Mål

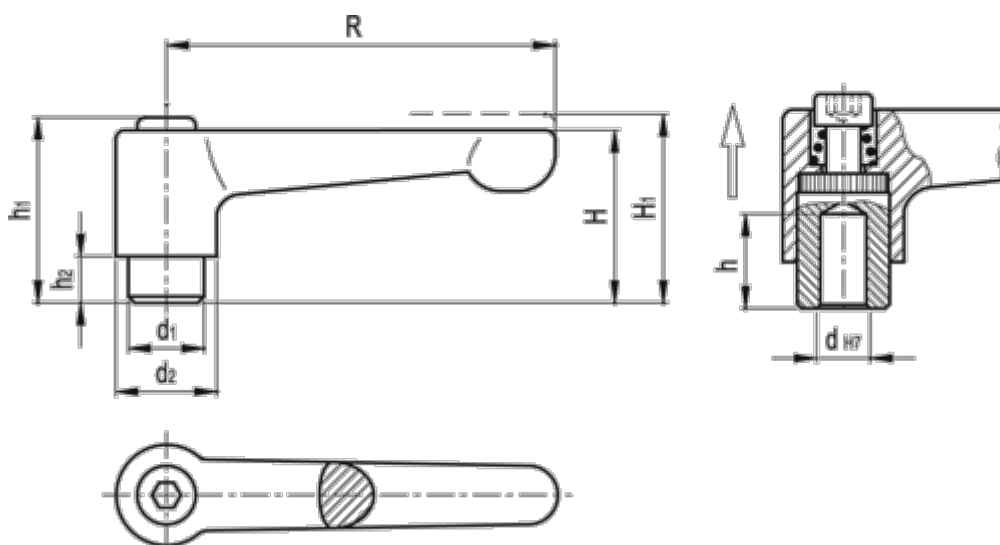

d1 = 10.0	R = 45
d2 = 13.0	Vægt (g) = 30
d H7 = 6.0	
h = 9	
H = 22.0	
h1 = 24.5	
H1 = 25.5	
h2 = 4.0	